

Square Bore Series With Cylindrical Outer Ring - Relubricable Type

GW 211PP17

Square Bore Series With Cylindrical Outer Ring - Relubricable Type

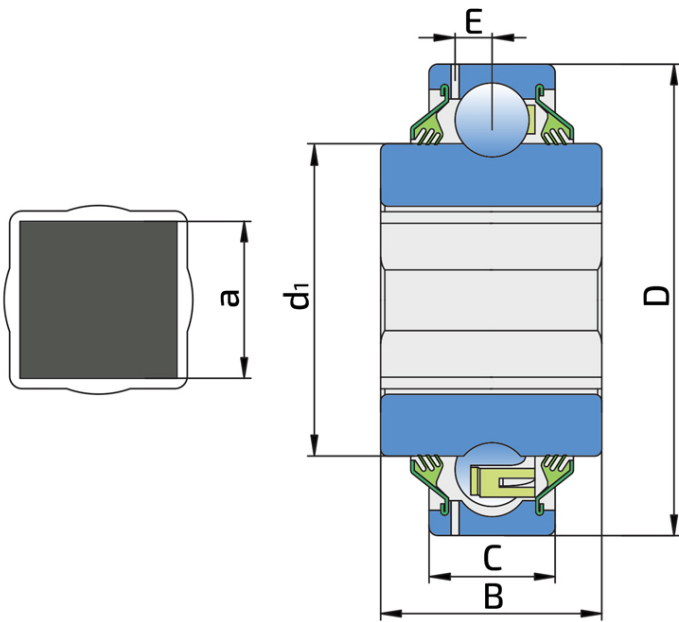

Technical Specification

D	Outside diameter	3.937 inch
D	Outside diameter	100 mm
B	Width inner ring	1.75 inch
B	Width inner ring	44.5 mm
C	Width outer ring	1.313 inch
C	Width outer ring	33.34 mm
d1	Outer diameter inner ring	2.72 inch
d1	Outer diameter inner ring	69.1 mm
E	Distance from raceway centre to the hole for lubrication	0.279 inch
E	Distance from raceway centre to the hole for lubrication	7.1 mm
a	Shaft size	1.53 inch
a	Shaft size	38.9 mm
C _{dyn}	Dynamic load rating	43.5 kN
C _o	Static load rating	29 kN
kg	Mass	1.188 kg

Sealing

T SEAL / T SEAL (2T)

3-lip seal on the both side of the bearing, provides equal protection against contamination. Recommended for application where the possibility of contamination is the same on the both side.

