

# Round Bore Series With Spherical Outer Ring - Relubricable Type

## GW 211PPB13

Round Bore Series With Spherical Outer Ring - Relubricable Type

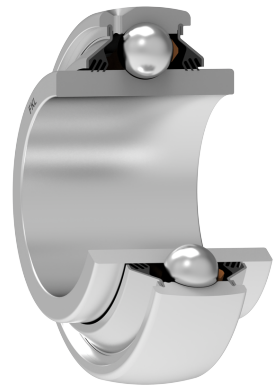
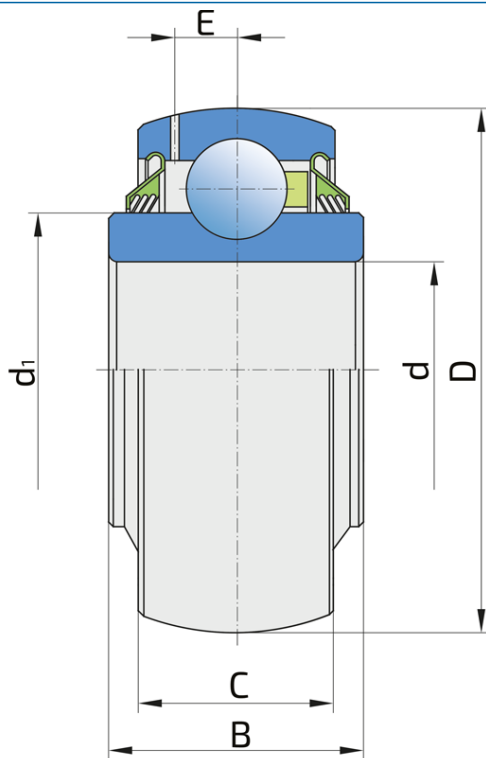

### Technical Specification

d	Bore diameter	1.785 inch
d	Bore diameter	45.34 mm
D	Outside diameter	3.937 inch
D	Outside diameter	100 mm
B	Width inner ring	1.313 inch
B	Width inner ring	33.34 mm
C	Width outer ring	0.984 inch
C	Width outer ring	25 mm
d1	Outer diameter inner ring	2.72 inch
d1	Outer diameter inner ring	69.1 mm
E	Distance from raceway centre to the hole for lubrication	0.28 inch
E	Distance from raceway centre to the hole for lubrication	7.1 mm
C <sub>dyn</sub>	Dynamic load rating	43.5 kN
C <sub>o</sub>	Static load rating	29 kN
kg	Mass	0.92 kg

## Sealing

---

### T SEAL / T SEAL (2T)

3-lip seal on the both side of the bearing, provides equal protection against contamination. Recommended for application where the possibility of contamination is the same on the both side.

