

Y-Bearing Take - Up Units With Grey Cast Iron Housings "T"

LYT 210 2F

Y-Bearing Take - Up Units With Grey Cast Iron Housings "T"

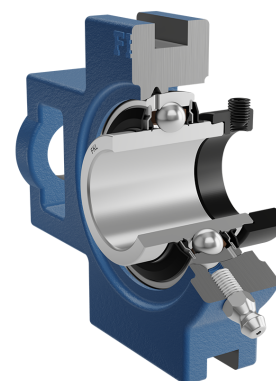
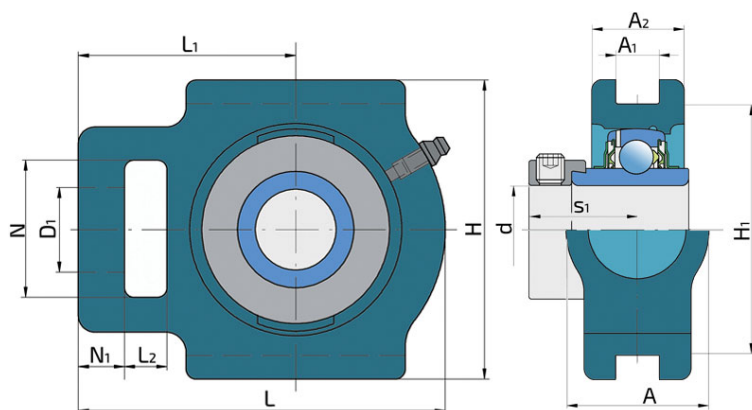
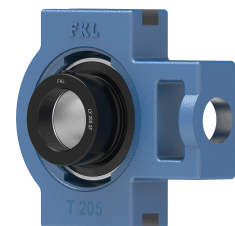

Technical Specification

d	Bore diameter	50 mm
D1	Hole diameter	29 mm
L	Overall length	149 mm
L1	Distance from the contact surface of housing to the bearing axis	90 mm
L2	Length of attachment slot	19 mm
A	Overall width	49 mm
A1	Width of location slot	17.5 mm
A2	Housing flange thickness	36 mm
H	Housing height	117 mm
H1	Distance between bottoms of location slot	101 mm
N	Height of attachment slot	49 mm
N1	Length attachment end	16 mm
s1	Distance from locking device side face to raceway centre	38.1 mm
kg	Mass	2.61 kg
Cdyn	Dynamic load rating	35.1 kN
Co	Static load rating	23.2 kN
Pu	Fatigue load limit	0.98 kN

Sealing

F SEAL / F SEAL (2F)

Dual sealing, protection cover placed on the inner ring protects against rough impurity particles and makes the labyrinth with the sheet part of the seal; then the sealing S type,

with the labyrinth between the sheet part and the rubber lip that conducts the contact sealing. The friction and speeds are the same as with S but has much better protection

against rough impurity particles. It is very good sealing system: the sheet part protects the seal from the soil, dust and

rough particles. At the same time makes the labyrinth with the rubber part. The rubber part provides the contact sealing that prevents the penetration of the finer impurities, water, moisture, steam etc. Suitable for heavier conditions due to better protection against foreign matters. It is used with the Y bearings (standard).

