

Y-Bearing Take - Up Units With Grey Cast Iron Housings "T"

LYT 207 2F

Y-Bearing Take - Up Units With Grey Cast Iron Housings "T"

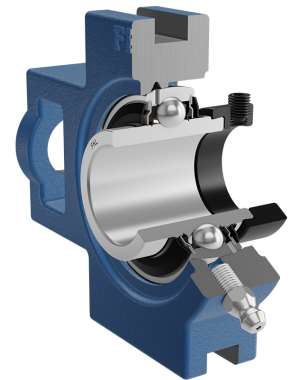
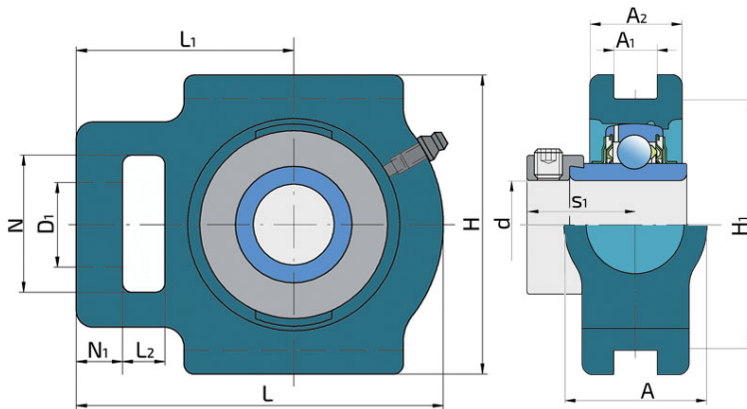

Technical Specification

d	Bore diameter	35 mm
D1	Hole diameter	22 mm
L	Overall length	129 mm
L1	Distance from the contact surface of housing to the bearing axis	78 mm
L2	Length of attachment slot	17 mm
A	Overall width	37 mm
A1	Width of location slot	13.5 mm
A2	Housing flange thickness	30 mm
H	Housing height	103 mm
H1	Distance between bottoms of location slot	89 mm
N	Height of attachment slot	38 mm
N1	Length attachment end	12 mm
s1	Distance from locking device side face to raceway centre	32.3 mm
kg	Mass	1.7 kg
Cdyn	Dynamic load rating	25.5 kN
Co	Static load rating	15.3 kN
Pu	Fatigue load limit	0.655 kN

Sealing

F SEAL / F SEAL (2F)

Dual sealing, protection cover placed on the inner ring protects against rough impurity particles and makes the labyrinth with the sheet part of the seal; then the sealing S type,

with the labyrinth between the sheet part and the rubber lip that conducts the contact sealing. The friction and speeds are the same as with S but has much better protection

against rough impurity particles. It is very good sealing system: the sheet part protects the seal from the soil, dust and

rough particles. At the same time makes the labyrinth with the rubber part. The rubber part provides the contact sealing that prevents the penetration of the finer impurities, water, moisture, steam etc. Suitable for heavier conditions due to better protection against foreign matters. It is used with the Y bearings (standard).

