

Y-Bearing Flanged Units With Round Grey Cast Iron Housing "G"

LEG 210 2F

Y-Bearing Flanged Units With Round Grey Cast Iron Housing "G"

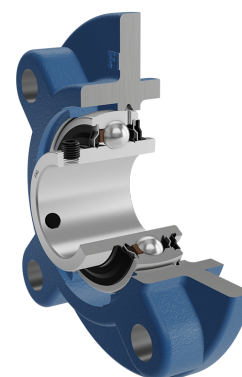
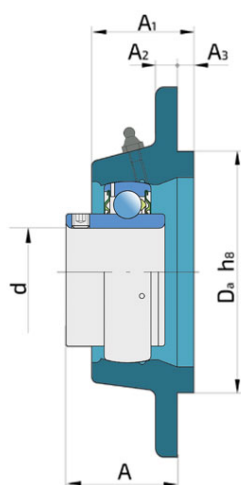
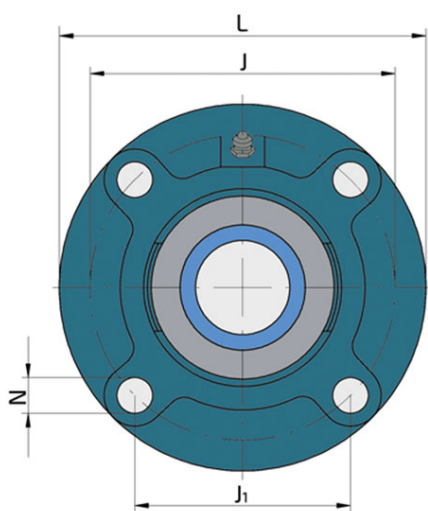

Technical Specification

d	Bore diameter	50 mm
Da	Centering diameter	110 mm
L	Overall width	165 mm
A	Distance from the housing flange to the front of the inner ring of the bearing	42.6 mm
A1	Total housing width	40 mm
A2	Housing flange thickness	14 mm
A3	Centering diameter height	12 mm
J	Pitch circle diameter	138 mm
J1	Distance between the holes	97.6 mm
N	Diameter of attachment slot	16 mm
kg	Mass	2.93 kg
Cdyn	Dynamic load rating	35.1 kN
Co	Static load rating	23.2 kN
Pu	Fatigue load limit	0.98 kN

Sealing

F SEAL / F SEAL (2F)

Dual sealing, protection cover placed on the inner ring protects against rough impurity particles and makes the labyrinth with the sheet part of the seal; then the sealing S type,

with the labyrinth between the sheet part and the rubber lip that conducts the contact sealing. The friction and speeds are the same as with S but has much better protection

against rough impurity particles. It is very good sealing system: the sheet part protects the seal from the soil, dust and

rough particles. At the same time makes the labyrinth with the rubber part. The rubber part provides the contact sealing that prevents the penetration of the finer impurities, water, moisture, steam etc. Suitable for heavier conditions due to better protection against foreign matters. It is used with the Y bearings (standard).

