

Y-Bearing Flanged Units With Round Grey Cast Iron Housing "G"

LSG 208 2F

Y-Bearing Flanged Units With Round Grey Cast Iron Housing "G"

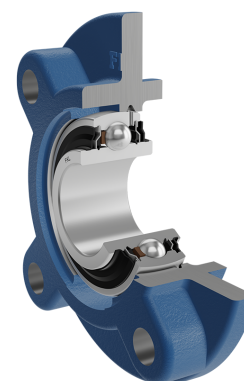
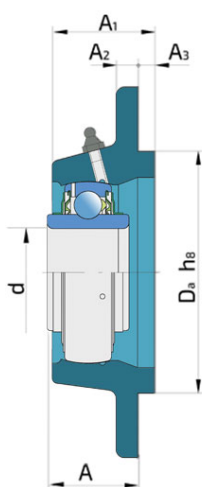
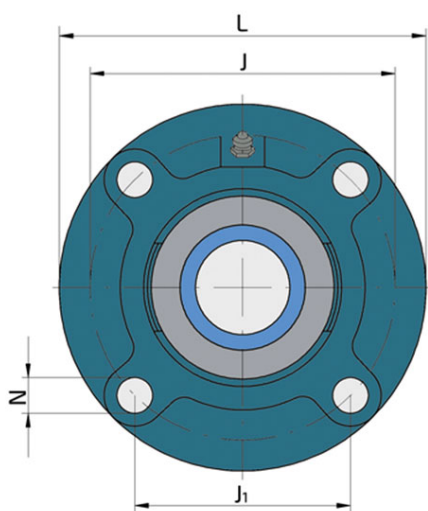

Technical Specification

d	Bore diameter	40 mm
Da	Centering diameter	100 mm
L	Overall width	145 mm
A	Distance from the housing flange to the front of the inner ring of the bearing	24.5 mm
A1	Total housing width	36 mm
A2	Housing flange thickness	9 mm
A3	Centering diameter height	10 mm
J	Pitch circle diameter	120 mm
J1	Distance between the holes	84.8 mm
N	Diameter of attachment slot	14 mm
kg	Mass	1.93 kg
Cdyn	Dynamic load rating	30.7 kN
Co	Static load rating	19 kN
Pu	Fatigue load limit	0.8 kN

Sealing

F SEAL / F SEAL (2F)

Dual sealing, protection cover placed on the inner ring protects against rough impurity particles and makes the labyrinth with the sheet part of the seal; then the sealing S type,

with the labyrinth between the sheet part and the rubber lip that conducts the contact sealing. The friction and speeds are the same as with S but has much better protection

against rough impurity particles. It is very good sealing system: the sheet part protects the seal from the soil, dust and

rough particles. At the same time makes the labyrinth with the rubber part. The rubber part provides the contact sealing that prevents the penetration of the finer impurities, water, moisture, steam etc. Suitable for heavier conditions due to better protection against foreign matters. It is used with the Y bearings (standard).

