

Y-Bearing Flanged Units With Round Grey Cast Iron Housing "G"

LEG 207 2F

Y-Bearing Flanged Units With Round Grey Cast Iron Housing "G"

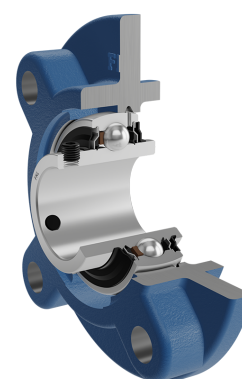
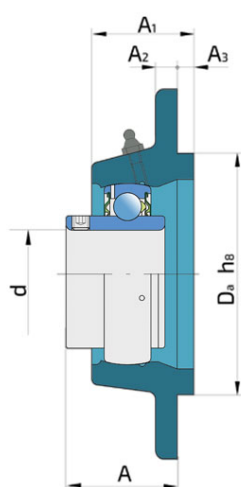
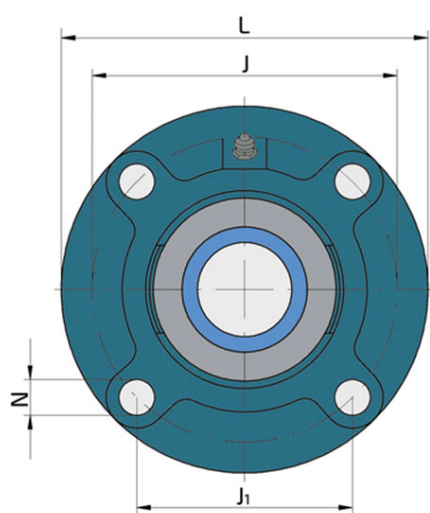

Technical Specification

d	Bore diameter	35 mm
Da	Centering diameter	90 mm
L	Overall width	135 mm
A	Distance from the housing flange to the front of the inner ring of the bearing	36.5 mm
A1	Total housing width	34 mm
A2	Housing flange thickness	9 mm
A3	Centering diameter height	8 mm
J	Pitch circle diameter	110 mm
J1	Distance between the holes	77.8 mm
N	Diameter of attachment slot	14 mm
kg	Mass	1.64 kg
Cdyn	Dynamic load rating	25.5 kN
Co	Static load rating	15.3 kN
Pu	Fatigue load limit	0.655 kN

Sealing

F SEAL / F SEAL (2F)

Dual sealing, protection cover placed on the inner ring protects against rough impurity particles and makes the labyrinth with the sheet part of the seal; then the sealing S type,

with the labyrinth between the sheet part and the rubber lip that conducts the contact sealing. The friction and speeds are the same as with S but has much better protection

against rough impurity particles. It is very good sealing system: the sheet part protects the seal from the soil, dust and

rough particles. At the same time makes the labyrinth with the rubber part. The rubber part provides the contact sealing that prevents the penetration of the finer impurities, water, moisture, steam etc. Suitable for heavier conditions due to better protection against foreign matters. It is used with the Y bearings (standard).

