

# Y-Bearing Flanged Units With Round Grey Cast Iron Housing "G"

## UYG 206 2S

Y-Bearing Flanged Units With Round Grey Cast Iron Housing "G"

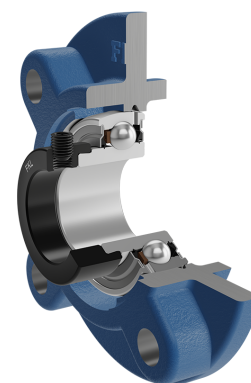
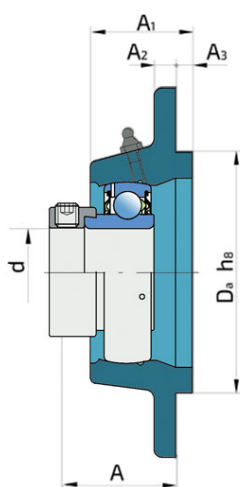
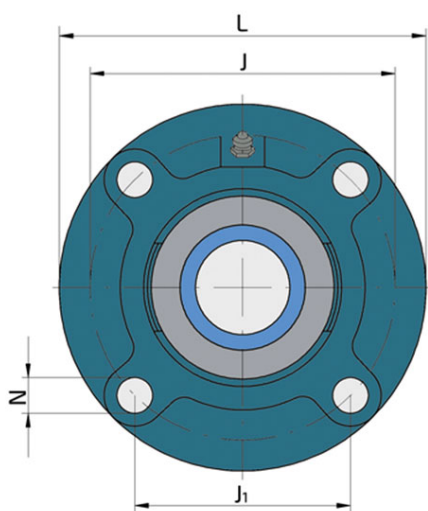

### Technical Specification

d	Bore diameter	30 mm
Da	Centering diameter	80 mm
L	Overall width	125 mm
A	Distance from the housing flange to the front of the inner ring of the bearing	36.7 mm
A1	Total housing width	31 mm
A2	Housing flange thickness	8 mm
A3	Centering diameter height	8 mm
J	Pitch circle diameter	100 mm
J1	Distance between the holes	70.7 mm
N	Diameter of attachment slot	12 mm
kg	Mass	1.4 kg
Cdyn	Dynamic load rating	19.5 kN
Co	Static load rating	11.2 kN
Pu	Fatigue load limit	0.475 kN

## Sealing

---

### S SEAL / S SEAL (2S)

Single lip seal with the labyrinth between the sheet part and the rubber lip which conducts the contact sealing. The friction and speeds are the same as with RS but provides much better protection against the rough impurity particles. This is very good sealing system: the sheet part protects the seal from the soil, dust and rough particles. At the same time makes the labyrinth with the rubber part. The rubber part provides contact sealing which prevents penetration of finer impurities, water, moisture, steam etc. Suitable for neutral conditions because of the presence of the foreign materials. It is used with the Y bearing (standard) and deep groove ball bearings.

