

# Y-Bearing Flanged Units With Square Grey Cast Iron Housing "F"

## LYF 211 2F

Y-Bearing Flanged Units With Square Grey Cast Iron Housing "F"

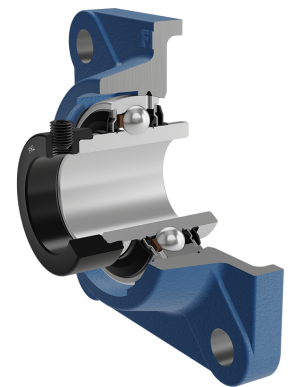
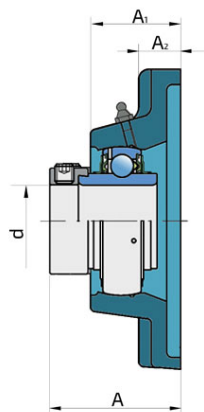
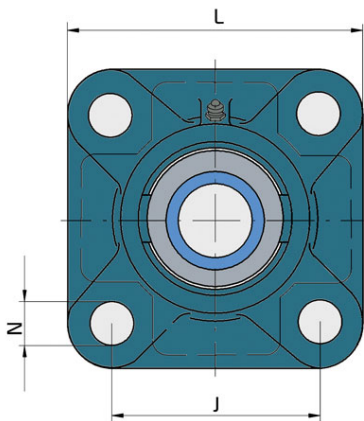

### Technical Specification

d	Bore diameter	55 mm
L	Overall width	162 mm
A	Distance from the housing flange to the front of the inner ring of the bearing	68.6 mm
A1	Total housing width	43 mm
A2	Housing flange thickness	17 mm
J	Pitch circle diameter	130 mm
N	Diameter of attachment slot	19 mm
kg	Mass	3.6 kg
Cdyn	Dynamic load rating	43.6 kN
Co	Static load rating	29 kN
Pu	Fatigue load limit	1.25 kN

## Sealing

---

### F SEAL / F SEAL (2F)

Dual sealing, protection cover placed on the inner ring protects against rough impurity particles and makes the labyrinth with the sheet part of the seal; then the sealing S type,

with the labyrinth between the sheet part and the rubber lip that conducts the contact sealing. The friction and speeds are the same as with S but has much better protection

against rough impurity particles. It is very good sealing system: the sheet part protects the seal from the soil, dust and

rough particles. At the same time makes the labyrinth with the rubber part. The rubber part provides the contact sealing that prevents the penetration of the finer impurities, water, moisture, steam etc. Suitable for heavier conditions due to better protection against foreign matters. It is used with the Y bearings (standard).

