

Y-Bearing Flanged Units With Square Grey Cast Iron Housing "F"

UYF 208 2S

Y-Bearing Flanged Units With Square Grey Cast Iron Housing "F"

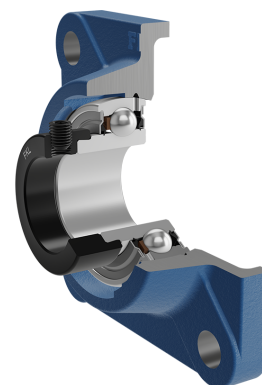
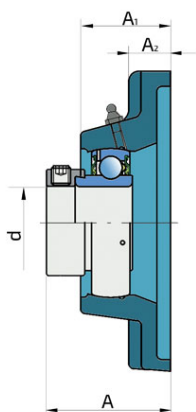
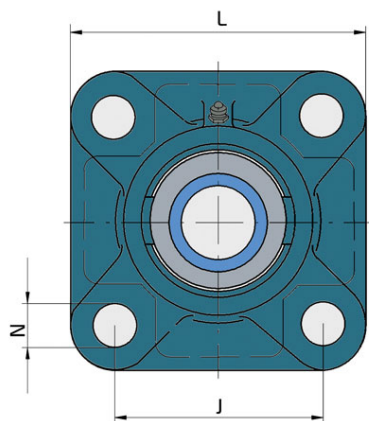

Technical Specification

| | | |
|------|--|---------|
| d | Bore diameter | 40 mm |
| L | Overall width | 130 mm |
| A | Distance from the housing flange to the front of the inner ring of the bearing | 53.7 mm |
| A1 | Total housing width | 36 mm |
| A2 | Housing flange thickness | 14 mm |
| J | Pitch circle diameter | 102 mm |
| N | Diameter of attachment slot | 16 mm |
| kg | Mass | 1.82 kg |
| Cdyn | Dynamic load rating | 30.7 kN |
| Co | Static load rating | 19 kN |
| Pu | Fatigue load limit | 0.8 kN |

Sealing

S SEAL / S SEAL (2S)

Single lip seal with the labyrinth between the sheet part and the rubber lip which conducts the contact sealing. The friction and speeds are the same as with RS but provides much better protection against the rough impurity particles. This is very good sealing system: the sheet part protects the seal from the soil, dust and rough particles. At the same time makes the labyrinth with the rubber part. The rubber part provides contact sealing which prevents penetration of finer impurities, water, moisture, steam etc. Suitable for neutral conditions because of the presence of the foreign materials. It is used with the Y bearing (standard) and deep groove ball bearings.

