

Y-Bearing Plummer Block Units With Grey Cast Iron Housing "V"

LEV 206 2F

Y-Bearing Plummer Block Units With Grey Cast Iron Housing "V"

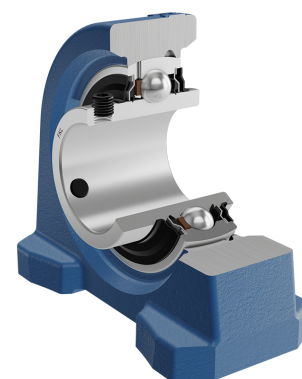
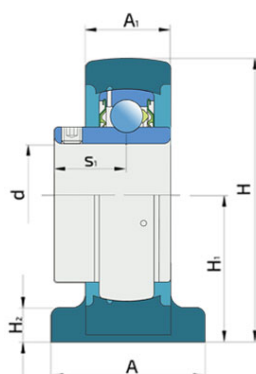
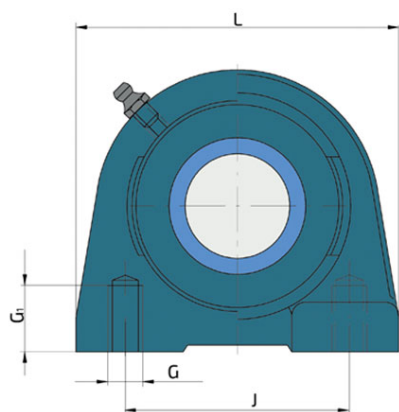
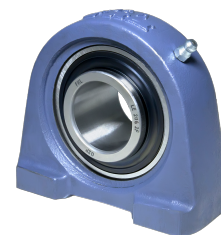

Technical Specification

d	Bore diameter	30 mm
L	Overall length	94 mm
A	Housing contact surface width	48 mm
A1	Width of the top of the housing	28.5 mm
H	Housing height	84 mm
H1	Distance from the contact surface to the bearing axis	10 mm
H2	Housing foot thickness	42.9 mm
J	Pitch circle diameter	66 mm
G	Thread	M15 mm
G1	Thread length	18 mm
s1	Distance from locking device side face to raceway centre	22.2 mm
kg	Mass	1.03 kg
Cdyn	Dynamic load rating	19.5 kN
Co	Static load rating	11.2 kN
Pu	Fatigue load limit	0.475 kN

Sealing

F SEAL / F SEAL (2F)

Dual sealing, protection cover placed on the inner ring protects against rough impurity particles and makes the labyrinth with the sheet part of the seal; then the sealing S type,

with the labyrinth between the sheet part and the rubber lip that conducts the contact sealing. The friction and speeds are the same as with S but has much better protection

against rough impurity particles. It is very good sealing system: the sheet part protects the seal from the soil, dust and

rough particles. At the same time makes the labyrinth with the rubber part. The rubber part provides the contact sealing that prevents the penetration of the finer impurities, water, moisture, steam etc. Suitable for heavier conditions due to better protection against foreign matters. It is used with the Y bearings (standard).

