

Y-Bearing Plummer Block Units With Grey Cast Iron Housing "S"

LYS 215 2F

Y-Bearing Plummer Block Units With Grey Cast Iron Housing "S"

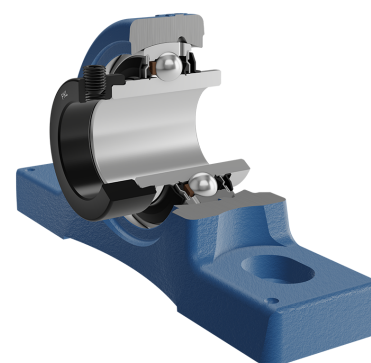
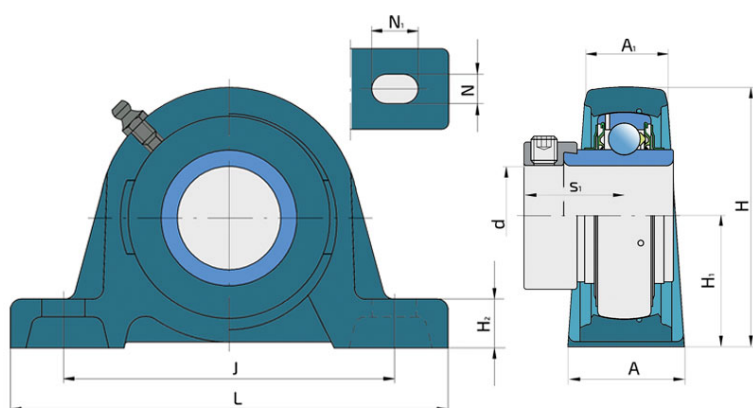
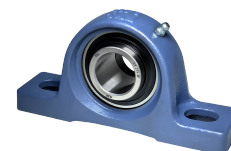

Technical Specification

d	Bore diameter	75 mm
L	Overall length	275 mm
A	Housing contact surface width	74 mm
A1	Width of the top of the housing	54 mm
H	Housing height	165 mm
H1	Distance from the contact surface to the bearing axis	82.5 mm
H2	Housing foot thickness	28 mm
Jmin	Min. distance between the holes	209 mm
Jmax	Max. distance between the holes	225 mm
N	Height of attachment slot	25 mm
N1	Length attachment end	33 mm
s1	Distance from locking device side face to raceway centre	54.8 mm
kg	Mass	8.4 kg
Cdyn	Dynamic load rating	66.3 kN
Co	Static load rating	49 kN
Pu	Fatigue load limit	2.04 kN

Sealing

F SEAL / F SEAL (2F)

Dual sealing, protection cover placed on the inner ring protects against rough impurity particles and makes the labyrinth with the sheet part of the seal; then the sealing S type,

with the labyrinth between the sheet part and the rubber lip that conducts the contact sealing. The friction and speeds are the same as with S but has much better protection

against rough impurity particles. It is very good sealing system: the sheet part protects the seal from the soil, dust and

rough particles. At the same time makes the labyrinth with the rubber part. The rubber part provides the contact sealing that prevents the penetration of the finer impurities, water, moisture, steam etc. Suitable for heavier conditions due to better protection against foreign matters. It is used with the Y bearings (standard).

