

Integrated Flange, Maintenance-Free Bearing For Independent Discs

IL50-98/4T-M22

Integrated Flange, Maintenance-Free Bearing For Independent Discs
Disc Harrow

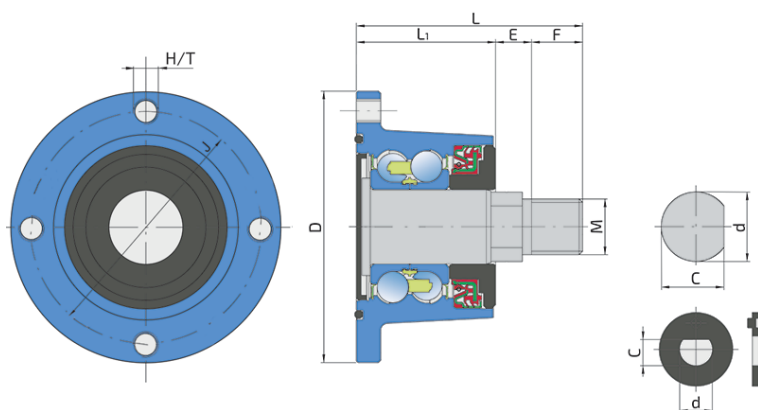

Technical Specification

J	Pitch circle diameter	98 mm
D	Outside diameter	117 mm
H/T	Hole/Thread	4xM12x1.25 mm
d	Bore diameter	27.95 mm
C	D-shape hole cut out dimension	25.4 mm
M	Outher Thread	M22x1.5 mm
L	Total length	102 mm
L1	Total flange length	60 mm
E	Length of D shape	17 mm
F	Length of threaded part	25 mm
kg	Mass	2.51 kg
C _{dyn}	Dynamic load rating	60 kN
C _o	Static load rating	45.8 kN
P _u	Fatigue load limit	1.92 kN

Sealing

O-RING+SHEET METAL SHIELD+RS SEAL / RS SEAL+DIRTBLOCK SEAL+FORGED COVER PLATE

O-ring, Sheet metal shield and RS seal on the base side and RS seal, Dirtblock seal with Forged cover plate on the front side which is exposed to contaminants.

O-ring, Sheet metal shield and RS seal together with attached disc eliminates the possibility of contamination from the base side.

Dirtblock seal is designed for hard working condition at unfriendly environment. Half metal - half rubber outside diameter provides reliable seal retention in the bore and improves sealing performance. Inside diameter is covered by rubber and improves sealing performance and easy installation. Forged cover plate is additional, strong protection of the Dirtblock seal against mechanical damage.

This sealing provides maximum protection against liquid or solid contaminants, which significantly extends bearing service life.

