

Y-Ball Bearings With Eccentric Locking Collar

UY 209 2S.SH

Y-Ball Bearings With Eccentric Locking Collar

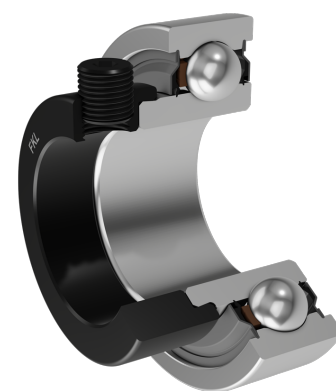
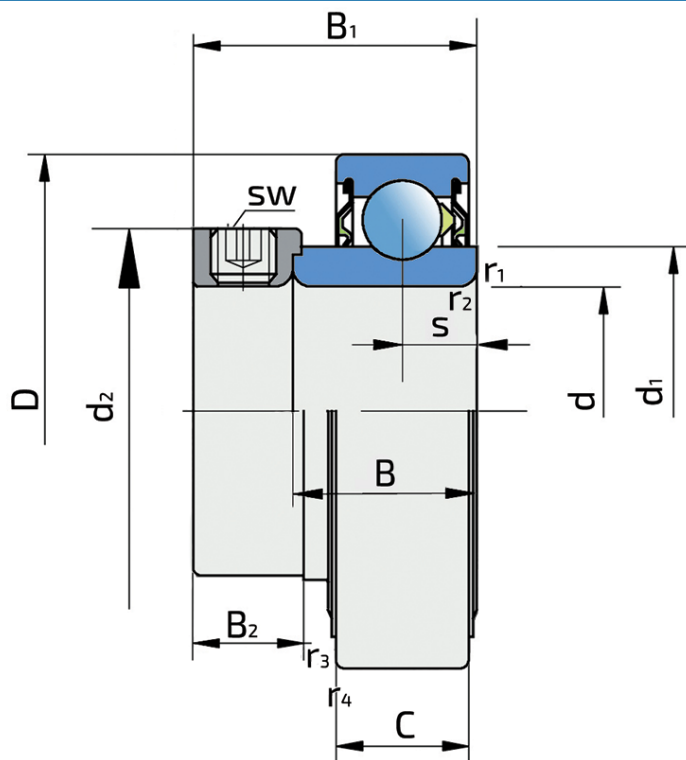

Technical Specification

d	Bore diameter	45 mm
D	Outside diameter	85 mm
B	Width inner ring	30.2 mm
C	Width outer ring	22 mm
s	Distance from inner ring side face to raceway centre	11 mm
d1	Outer diameter inner ring	56.6 mm
E	Distance from raceway centre to the hole for lubrication	6.1 mm
Gs	Set screw	M10x2 mm
sw	Hexagonal key size for set screw	5 mm
r1,2	Inner ring Chamfer dimension	1 mm
r3,4	Outside ring Chamfer dimension	1.5 mm
B1	Width inner ring with locking collar	43.7 mm
d2	Locking collar outside diameter	63.6 mm
B2	Width locking collar	18.3 mm
Cdyn	Dynamic load rating	33.2 kN
Co	Static load rating	21.6 kN
Pu	Fatigue load limit	0.92 kN
kg	Mass	0.65 kg

Sealing

S SEAL / S SEAL (2S)

Single lip seal with the labyrinth between the sheet part and the rubber lip which conducts the contact sealing. The friction and speeds are the same as with RS but provides much better protection against the rough impurity particles. This is very good sealing system: the sheet part protects the seal from the soil, dust and rough particles. At the same time makes the labyrinth with the rubber part. The rubber part provides contact sealing which prevents penetration of finer impurities, water, moisture, steam etc. Suitable for neutral conditions because of the presence of the foreign materials. It is used with the Y bearing (standard) and deep groove ball bearings.

