

Y-Ball Bearings With Grub Screw Locking

LE 214 2F

Y-Ball Bearings With Grub Screw Locking

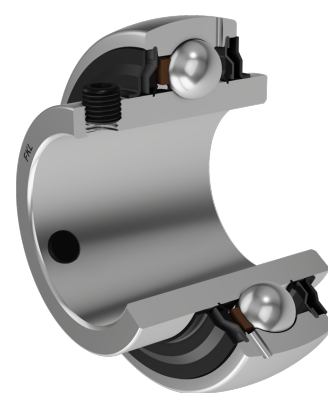
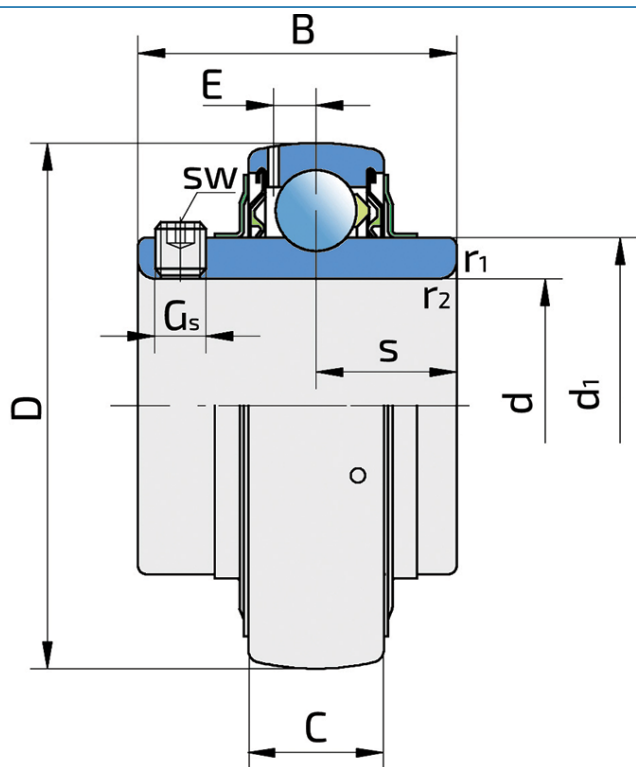

Technical Specification

d	Bore diameter	70 mm
D	Outside diameter	125 mm
B	Width inner ring	69.9 mm
C	Width outer ring	28 mm
s	Distance from inner ring side face to raceway centre	30.2 mm
d1	Outer diameter inner ring	87.1 mm
E	Distance from raceway centre to the hole for lubrication	8.1 mm
Gs	Set screw	M10x1 mm
sw	Hexagonal key size for set screw	5 mm
r1,2	Inner ring Chamfer dimension	1.5 mm
r3,4	Outside ring Chamfer dimension	2 mm
Cdyn	Dynamic load rating	62.4 kN
Co	Static load rating	44 kN
Pu	Fatigue load limit	1.86 kN
kg	Mass	1.9 kg

Sealing

F SEAL / F SEAL (2F)

Dual sealing, protection cover placed on the inner ring protects against rough impurity particles and makes the labyrinth with the sheet part of the seal; then the sealing S type,

with the labyrinth between the sheet part and the rubber lip that conducts the contact sealing. The friction and speeds are the same as with S but has much better protection

against rough impurity particles. It is very good sealing system: the sheet part protects the seal from the soil, dust and

rough particles. At the same time makes the labyrinth with the rubber part. The rubber part provides the contact sealing that prevents the penetration of the finer impurities, water, moisture, steam etc. Suitable for heavier conditions due to better protection against foreign matters. It is used with the Y bearings (standard).

