

# Y-Ball Bearings With Eccentric Locking Collar

## UY 207-104 2S.SH

Y-Ball Bearings With Eccentric Locking Collar

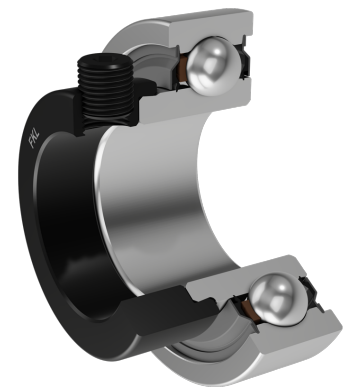
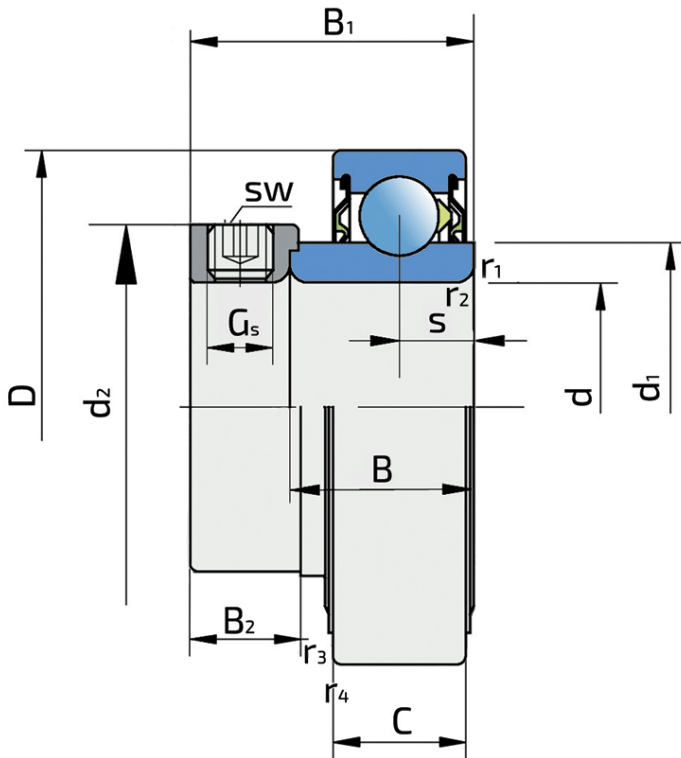

### Technical Specification

d	Bore diameter	31.75 mm
D	Outside diameter	72 mm
B	Width inner ring	25.4 mm
C	Width outer ring	19 mm
s	Distance from inner ring side face to raceway centre	9.5 mm
d1	Outer diameter inner ring	46.1 mm
Gs	Set screw	3/8-24 UNF inch
sw	Hexagonal key size for set screw	4.763 mm
sw	Hexagonal key size for set screw	3/16 inch
r1,2	Inner ring Chamfer dimension	1 mm
r3,4	Outside ring Chamfer dimension	1 mm
B1	Width inner ring with locking collar	38.9 mm
d2	Locking collar outside diameter	51.2 mm
B2	Width locking collar	17.5 mm
kg	Mass	0.495 kg
Cdyn	Dynamic load rating	25.5 kN
Co	Static load rating	15.3 kN
Pu	Fatigue load limit	0.66 kN

## Sealing

---

### S SEAL / S SEAL (2S)

Single lip seal with the labyrinth between the sheet part and the rubber lip which conducts the contact sealing. The friction and speeds are the same as with RS but provides much better protection against the rough impurity particles. This is very good sealing system: the sheet part protects the seal from the soil, dust and rough particles. At the same time makes the labyrinth with the rubber part. The rubber part provides contact sealing which prevents penetration of finer impurities, water, moisture, steam etc. Suitable for neutral conditions because of the presence of the foreign materials. It is used with the Y bearing (standard) and deep groove ball bearings.

