

Y-Ball Bearings With Eccentric Locking Collar

UY 208-108 2S.H

Y-Ball Bearings With Eccentric Locking Collar

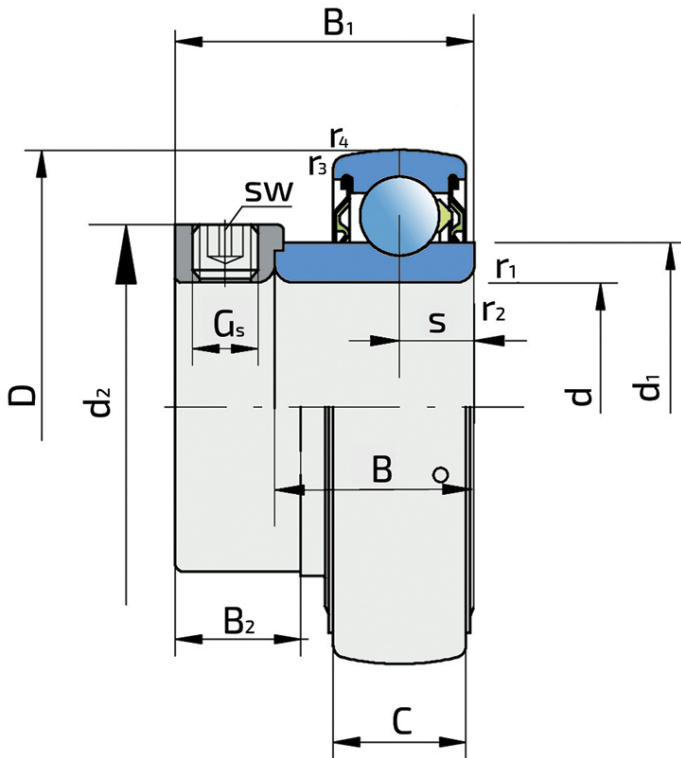

Technical Specification

d	Bore diameter	38.1 mm
D	Outside diameter	80 mm
B	Width inner ring	29.7 mm
C	Width outer ring	21 mm
s	Distance from inner ring side face to raceway centre	11 mm
d1	Outer diameter inner ring	51.8 mm
Gs	Set screw	3/8-24 UNF inch
sw	Hexagonal key size for set screw	4.763 mm
sw	Hexagonal key size for set screw	3/16 inch
r1,2	Inner ring Chamfer dimension	1 mm
r3,4	Outside ring Chamfer dimension	1.5 mm
B1	Width inner ring with locking collar	43.7 mm
d2	Locking collar outside diameter	58.2 mm
B2	Width locking collar	18.3 mm
kg	Mass	0.623 kg
Cdyn	Dynamic load rating	32.5 kN
Co	Static load rating	19.8 kN
Pu	Fatigue load limit	0.832 kN

Sealing

S SEAL / S SEAL (2S)

Single lip seal with the labyrinth between the sheet part and the rubber lip which conducts the contact sealing. The friction and speeds are the same as with RS but provides much better protection against the rough impurity particles. This is very good sealing system: the sheet part protects the seal from the soil, dust and rough particles. At the same time makes the labyrinth with the rubber part. The rubber part provides contact sealing which prevents penetration of finer impurities, water, moisture, steam etc. Suitable for neutral conditions because of the presence of the foreign materials. It is used with the Y bearing (standard) and deep groove ball bearings.

