

Y-Ball Bearings With Eccentric Locking Collar

UY 205-100 2S.SH

Y-Ball Bearings With Eccentric Locking Collar

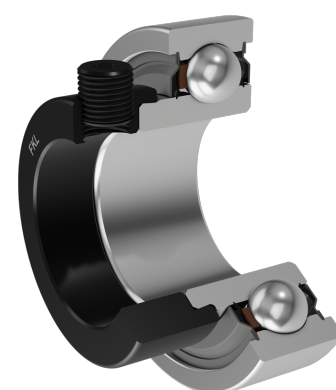
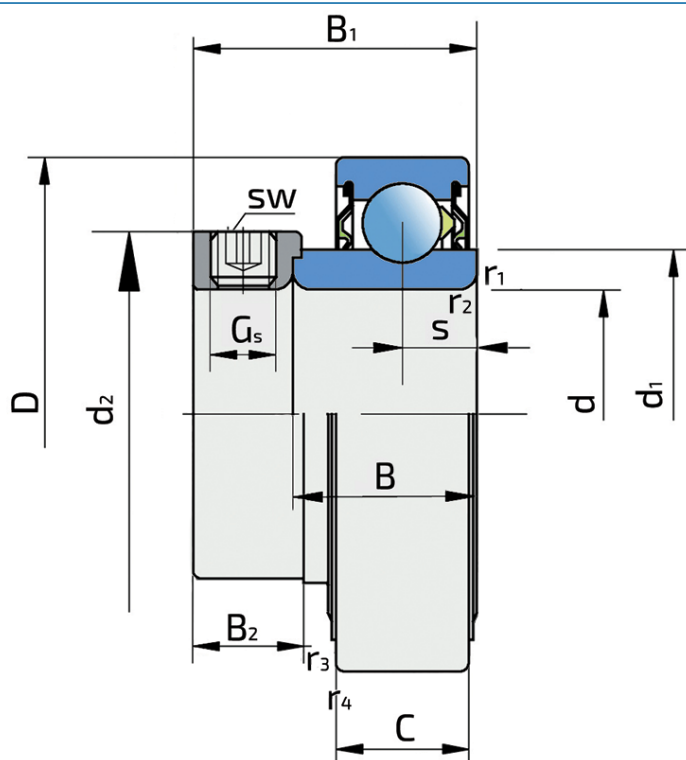

Technical Specification

d	Bore diameter	25.4 mm
D	Outside diameter	52 mm
B	Width inner ring	21.5 mm
C	Width outer ring	15 mm
s	Distance from inner ring side face to raceway centre	7.5 mm
d1	Outer diameter inner ring	33.6 mm
Gs	Set screw	1/4-28 UNF inch
sw	Hexagonal key size for set screw	3.175 mm
sw	Hexagonal key size for set screw	1/8 inch
r1,2	Inner ring Chamfer dimension	0.6 mm
r3,4	Outside ring Chamfer dimension	0.6 mm
B1	Width inner ring with locking collar	31 mm
d2	Locking collar outside diameter	37.4 mm
B2	Width locking collar	13.5 mm
kg	Mass	0.184 kg
Cdyn	Dynamic load rating	14 kN
Co	Static load rating	7.8 kN
Pu	Fatigue load limit	0.34 kN

Sealing

S SEAL / S SEAL (2S)

Single lip seal with the labyrinth between the sheet part and the rubber lip which conducts the contact sealing. The friction and speeds are the same as with RS but provides much better protection against the rough impurity particles. This is very good sealing system: the sheet part protects the seal from the soil, dust and rough particles. At the same time makes the labyrinth with the rubber part. The rubber part provides contact sealing which prevents penetration of finer impurities, water, moisture, steam etc. Suitable for neutral conditions because of the presence of the foreign materials. It is used with the Y bearing (standard) and deep groove ball bearings.

