

Y-Ball Bearings With Eccentric Locking Collar

LY 207-104 2F

Y-Ball Bearings With Eccentric Locking Collar

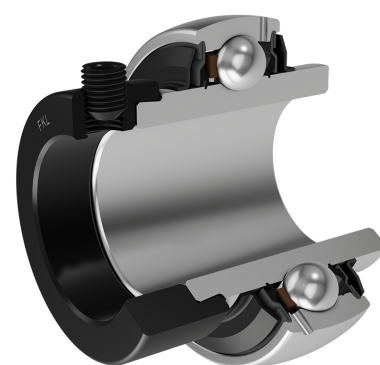
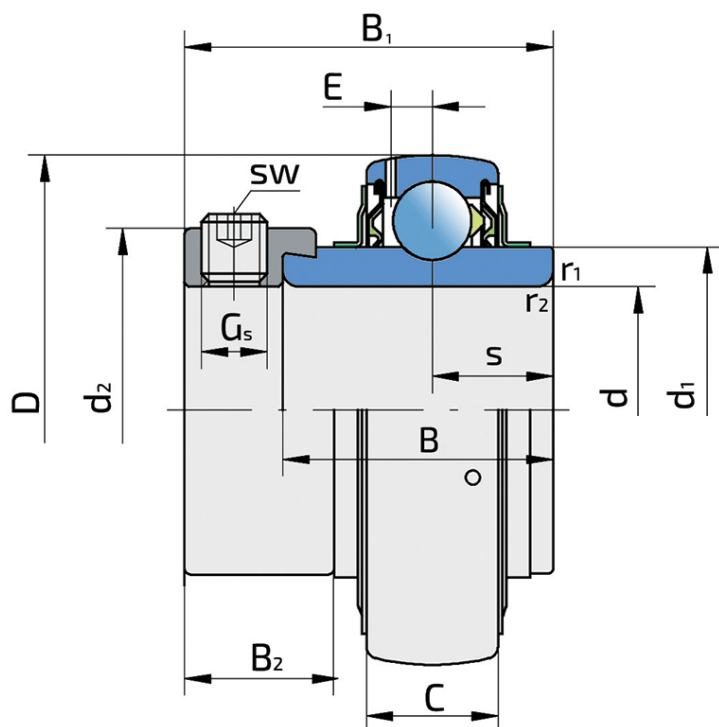

Technical Specification

d	Bore diameter	31.75 mm
D	Outside diameter	72 mm
B	Width inner ring	37.6 mm
C	Width outer ring	19 mm
s	Distance from inner ring side face to raceway centre	18.8 mm
d1	Outer diameter inner ring	46.1 mm
E	Distance from raceway centre to the hole for lubrication	5.6 mm
Gs	Set screw	3/8-24 UNF inch
sw	Hexagonal key size for set screw	4.763 mm
sw	Hexagonal key size for set screw	3/16 inch
r1,2	Inner ring Chamfer dimension	1 mm
r3,4	Outside ring Chamfer dimension	1 mm
B1	Width inner ring with locking collar	51.1 mm
d2	Locking collar outside diameter	51.2 mm
B2	Width locking collar	17.5 mm
kg	Mass	0.57 kg
Cdyn	Dynamic load rating	25.5 kN
Co	Static load rating	15.3 kN
Pu	Fatigue load limit	0.66 kN

Sealing

F SEAL / F SEAL (2F)

Dual sealing, protection cover placed on the inner ring protects against rough impurity particles and makes the labyrinth with the sheet part of the seal; then the sealing S type,

with the labyrinth between the sheet part and the rubber lip that conducts the contact sealing. The friction and speeds are the same as with S but has much better protection

against rough impurity particles. It is very good sealing system: the sheet part protects the seal from the soil, dust and

rough particles. At the same time makes the labyrinth with the rubber part. The rubber part provides the contact sealing that prevents the penetration of the finer impurities, water, moisture, steam etc. Suitable for heavier conditions due to better protection against foreign matters. It is used with the Y bearings (standard).

