

Y-Bearing Flanged Units With Square Grey Cast Iron Housing "F"

LEF 210 2T

Y-Bearing Flanged Units With Square Grey Cast Iron Housing "F"

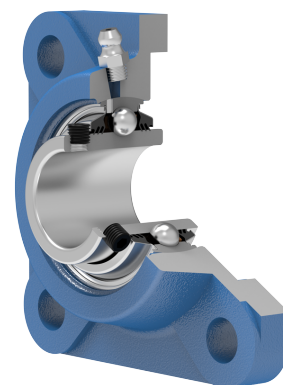
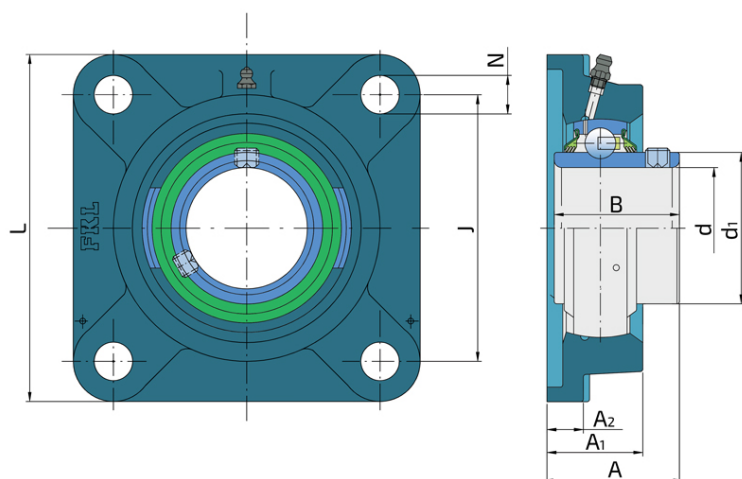
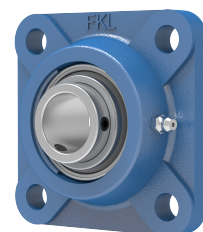

Technical Specification

d	Bore diameter	50 mm
d1	Outer diameter inner ring	62.5 mm
L	Total length	143 mm
J	Distance between the holes	111 mm
N	Hole diameter	16H13 mm
A	Overall width	54.6 mm
A1	Total housing width	40 mm
A2	Housing flange thickness	11 mm
B	Width inner ring	51.6 mm
kg	Mass	2.6 kg
Cdyn	Dynamic load rating	35.1 kN
Co	Static load rating	23.2 kN
Pu	Fatigue load limit	0.974 kN

Sealing

T SEAL / T SEAL (2T)

3-lip seal on the both side of the bearing, provides equal protection against contamination. Recommended for application where the possibility of contamination is the same on the both side.

