

Y-Ball Bearings With Grub Screw Locking

LE 215 2TB

Y-Ball Bearings With Grub Screw Locking

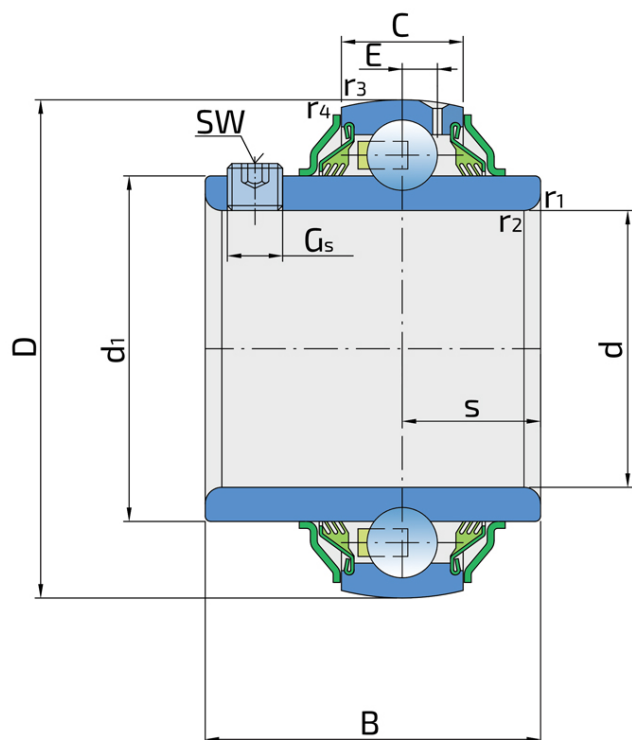

Technical Specification

| | | |
|------------------|--|----------|
| d | Bore diameter | 75 mm |
| D | Outside diameter | 130 mm |
| B | Width inner ring | 73.3 mm |
| C | Width outer ring | 29 mm |
| s | Distance from inner ring side face to raceway centre | 27 mm |
| d1 | Outer diameter inner ring | 92.1 mm |
| E | Distance from raceway centre to the hole for lubrication | 8.3 mm |
| Gs | Set screw | M10x1 mm |
| sw | Hexagonal key size for set screw | 5 mm |
| r1,2 | Inner ring Chamfer dimension | 1.5 mm |
| r3,4 | Outside ring Chamfer dimension | 2 mm |
| C _{dyn} | Dynamic load rating | 66.3 kN |
| C _o | Static load rating | 49 kN |
| P _u | Fatigue load limit | 2.04 kN |
| kg | Mass | 2.1 kg |

Sealing

METAL FLINGER RING+T SEAL / T SEAL+ METAL FLINGER RING (2TB)

3-lip seal with Metal flinger ring on the both side of the bearing, provides equal protection against contamination. The Metal flinger ring protects the seal from mechanical damage.

